



**2.4m STRAIGHT INTERMEDIATE POST**

**BSPSI24**

**ALL DIMENSIONS  
IN MM**

**Post:  
40 x 40 x 3 RHS**

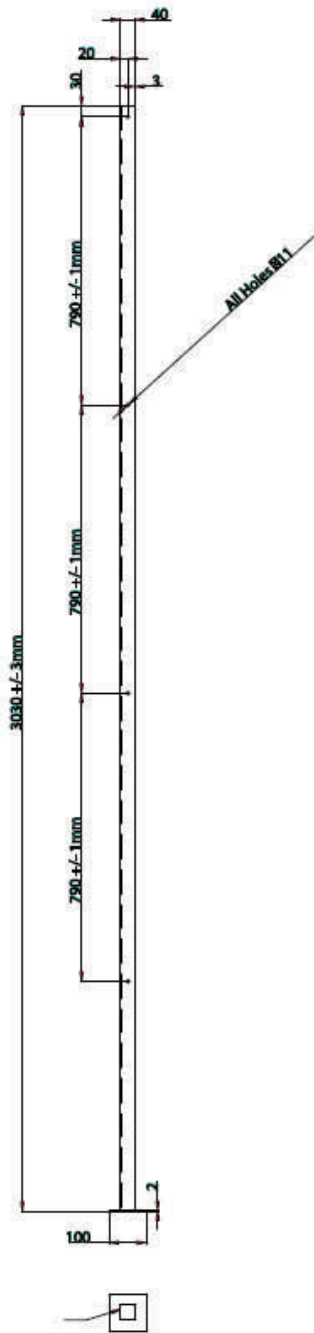
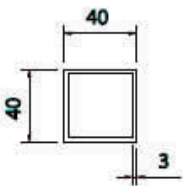

**Post at centre of  
Base plate**



**100 X 100 X 2  
Base plate**



**2.4m STRAIGHT RIGHT HAND END POST**

**BSPSE24**

ALL DIMENSIONS  
IN MM

Post:  
50 x 50 x 3 RHS

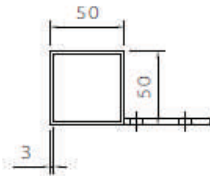

Strut:  
40 x 40 x 2.5 RHS

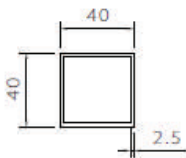

END POST SET-UP:  
1 POST + 1 STRUTS

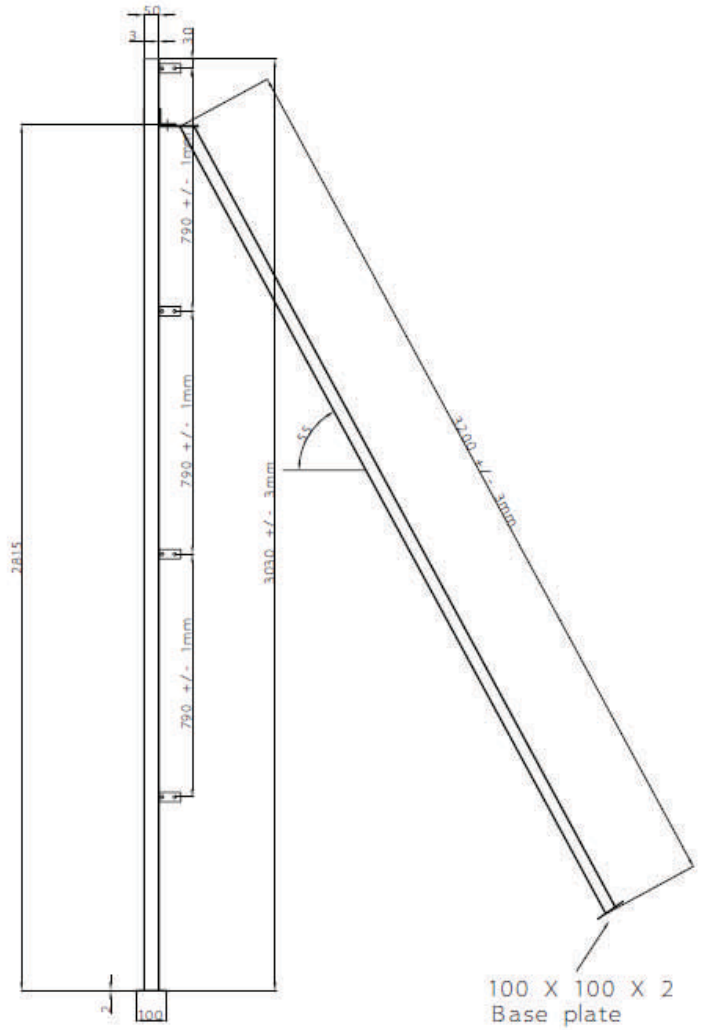
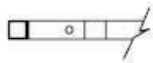

Post at centre of  
Base plate

**BSPSE24**



**2.4m STRAIGHT LEFT HAND END POST**

**BSPSE24**

ALL DIMENSIONS  
IN MM

Post:  
50 x 50 x 3 RHS

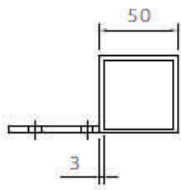

Strut:  
40 x 40 x 2.5 RHS

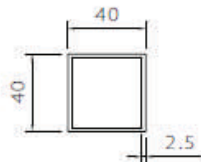

STRAINING POST  
SET-UP:  
1 POST + 1 STRUTS

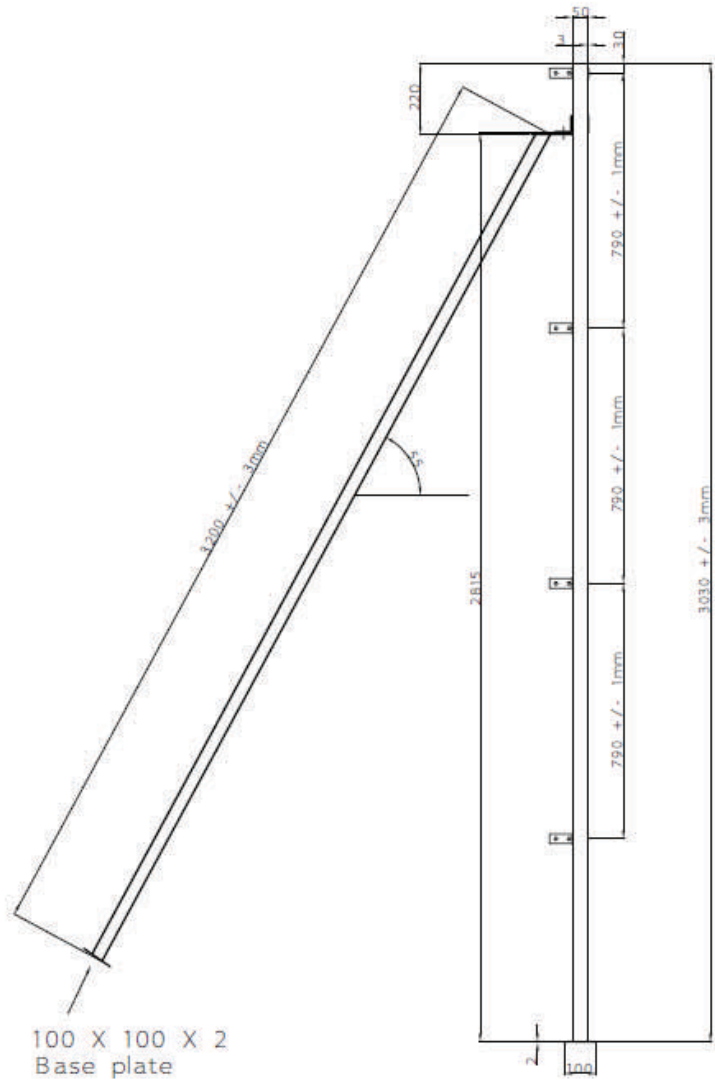
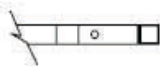

100 X 100 X 2  
Base plate

Post at centre of  
Base plate

**BSPSE24**



**2.4m STRAIGHT TWOWAY POST**

**BSPST24**

ALL DIMENSIONS  
IN MM

Post:  
50 x 50 x 3 RHS

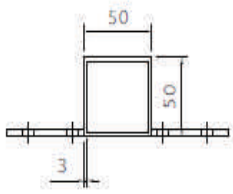

Strut:  
40 x 40 x 2.5 RHS

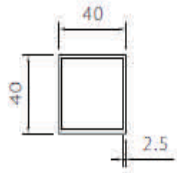

STRAINING POST  
SET-UP:  
1 POST + 2 STRUTS

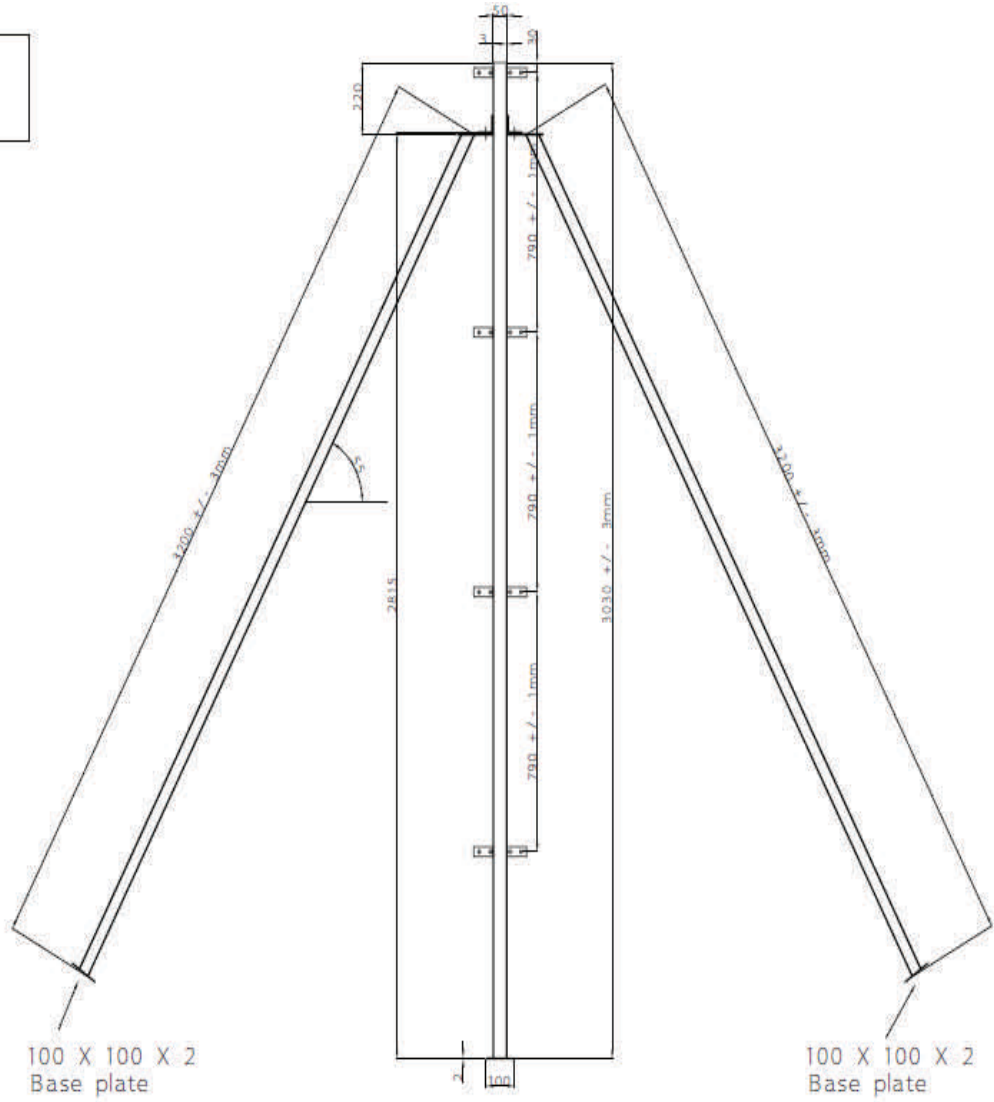
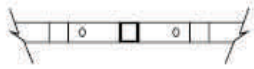

Post at centre of  
Base plate

**BSPST24**



**2.4m STRAIGHT CORNER POST**

**BSPSC24**

ALL DIMENSIONS  
IN MM

Post:  
50 x 50 x 3 RHS

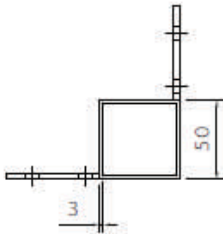

Strut:  
40 x 40 x 2.5 RHS

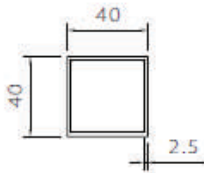

CORNER POST  
SET - UP:  
1 POST + 2 STRUTS

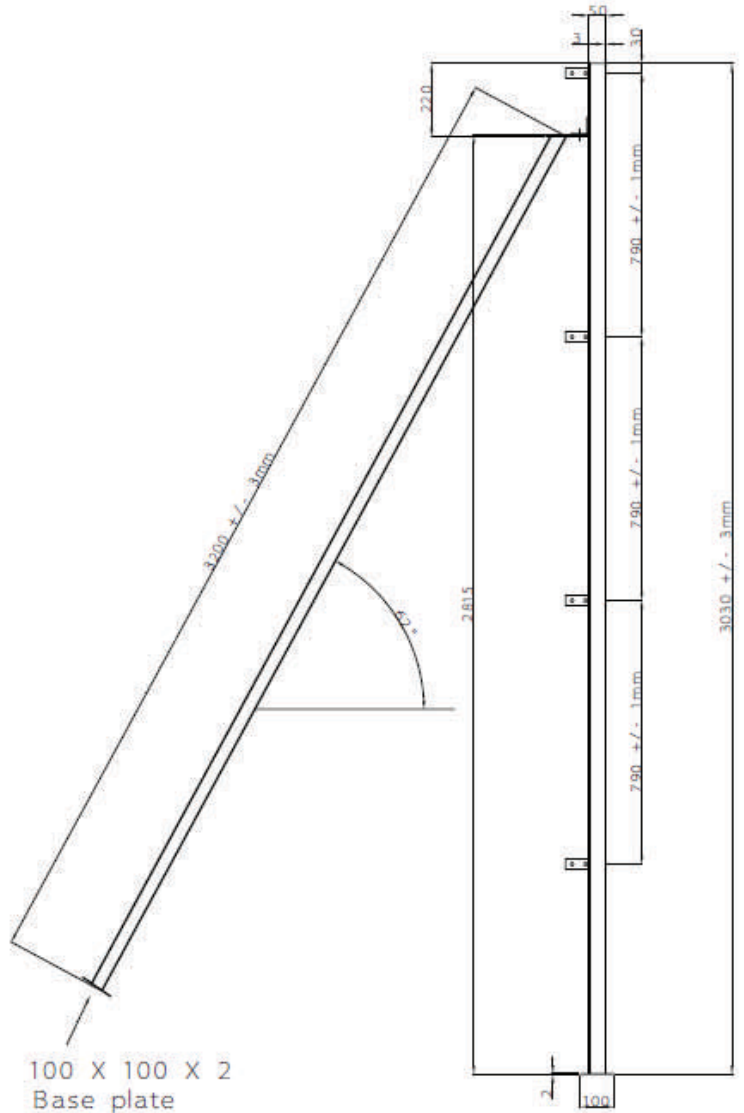
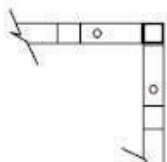

100 X 100 X 2  
Base plate

Post at centre of  
Base plate

**BSPSC24**